



MOVAX

Total Piling Solutions

SG, SIDE GRIP
PILE DRIVER, STD

TECHNICAL SPECIFICATION



VALID FROM JAN 2023

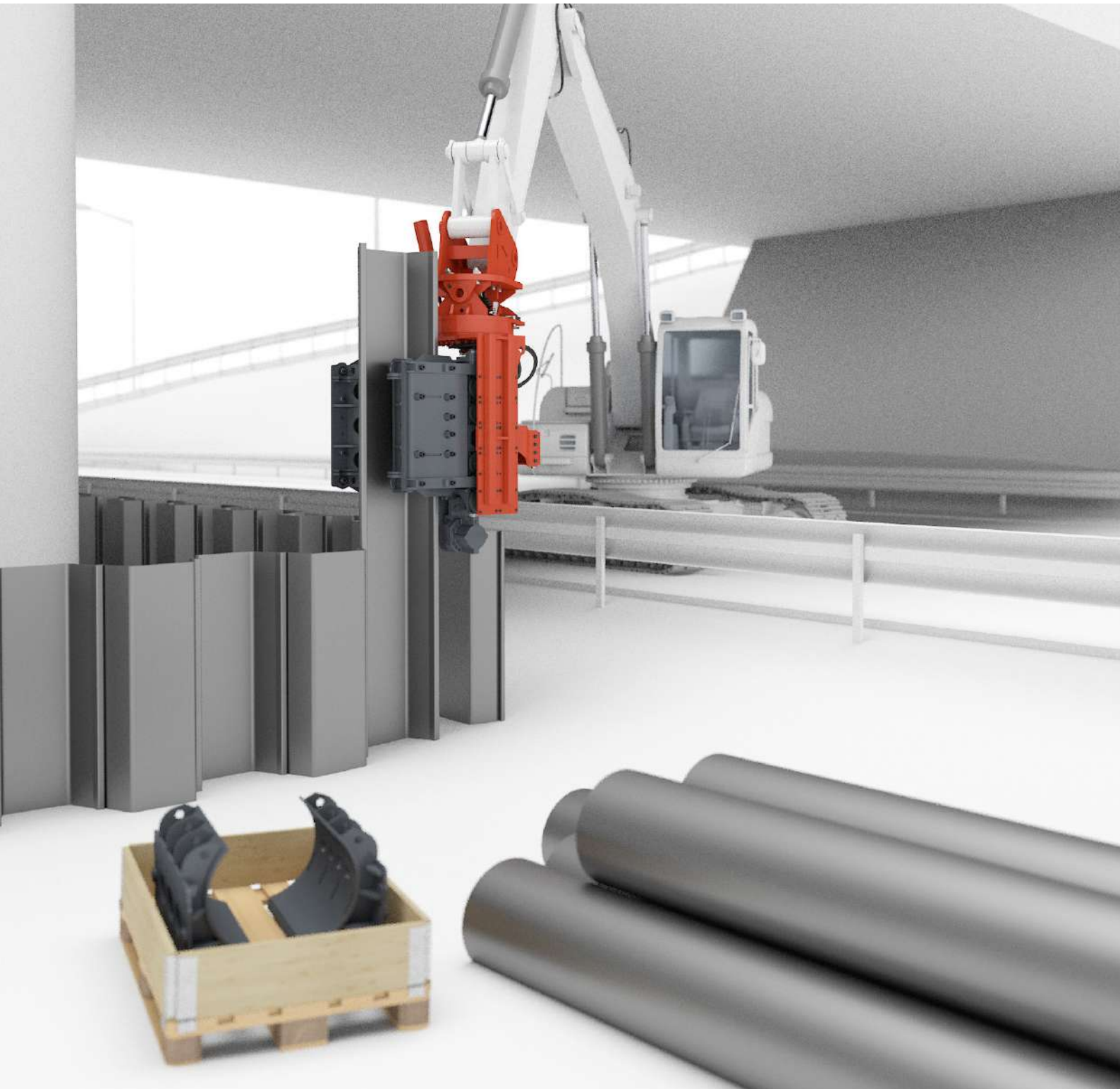

HIGHER PRODUCTIVITY – SIGNIFICANT SAVINGS

Efficient. Fast. Versatile. Accurate. Safe. Reliable.

MOVAX WAY-OF-PILING

INTRODUCTION

Movax Oy, established in 1993, is a Finnish-based, privately-owned world-leading innovator, developer and manufacturer of excavator-mounted piling and foundation equipment with highly advanced automatic control systems and information management solutions.

A TOTAL SOLUTION

Movax Oy focuses solely on solutions for the piling & foundation industry. The comprehensive range of excavator-mounted piling & foundation equipment and customized solutions cover a complete range of piling technologies - including both driven and bored piles.

UNIQUE, VALUE-ADDING TECHNOLOGY

Movax Oy's piling and foundation equipment provide the optimum way-of-working - **MOVAX WAY-OF-PILING™** - when constructing foundations, building retaining walls, both temporary and permanent, cofferdams and when performing trenching and excavation work and soil stabilisation in a wide range of applications.

QUALITY BUILT-TO-LAST

MOVAX is made with high-class materials, equipment and components – and modern, state-of-the-art production technologies and machinery ensuring the highest possible quality of manufacture. Movax Oy's Quality Management Systems is certified on accordance with ISO 9001:2015.

GLOBALLY PROVEN

With almost **30 years of experience** and more than **3000 units delivered** to all over the world and with a clear focus on the piling and foundation industry, MOVAX has a deep understanding and know-how of varying site and soil conditions - and of all kinds of different type of excavators and rail roaders. Movax Oy's experience also covers a wide range of applications ranging from Rail, Road and Civil to Waterways & Piers, Utilities and Environmental & Energy.

GLOBALLY LOCAL CUSTOMER CARE

Movax Oy focuses on superior customer service and support together with a world-wide network of local partners, established in more than 30 countries all over the world, performing trenching and excavation work in a wide range of applications from civil/structural, rail and road to waterways & piers, utilities and environmental.



INNOVATION & CONTINUOUS DEVELOPMENT

Movax Oy is the inventor of the modular, vibratory side grip pile driver technology. Movax Oy's inventions have resulted in numerous patents (50+) and its trademark, MOVAX®, is registered and well known for the quality it represents all over the world.

Movax Oy is strongly committed to continuously develop its products and services in close cooperation with its customers and local partners.



TOTAL SOLUTION

PILING, FOUNDATION & SOIL STABILISATION

MOVAX excavator mounted piling equipment and customised solutions are available for different piling technologies, including both driven and bored piles, and for varying site and soil conditions and requirements.

The MOVAX Control System links the excavator with the MOVAX piling equipment and customised solutions whereas the MOVAX Information Management System (MIMS) provides essential information about the piling process and the pile installation - and about the MOVAX piling equipment.



PILE DRIVERS

Side grip vibratory-type pile driver for handling, pitching, driving & extracting a complete range of driven piles, including sheet piles, H-beams, tubular steel piles and timber piles.



PILING HAMMERS

Hydraulic, double-acting impact-type piling hammers for driving load-bearing piles or assisting in sheet pile driving in even the most difficult soil conditions.



PILING DRILLS

Telescopic/kelly bar-type piling drills for bored, cast-in-situ (concrete) piles.



MOVAX CONTROL SYSTEM

The **MOVAX Control System (mControl+)** controls all MOVAX piling equipment and customised solutions. The system controls the auxiliary hydraulics of the excavator and all the functions of MOVAX's piling equipment.



MULTI-TOOL PILING LEADERS

Customised multi-purpose piling leaders with tooling including vibratory pile driver, piling hammer and rotary drives for pre-augering and CFA piling.



COLUMN STABILISATION LEADERS

Customised column stabilisation leader for increasing strength, improving deformation properties and to increase stiffness of soft soil.



INFORMATION MANAGEMENT

The **MOVAX Information Management System (MIMS)** provides essential information about the piling process and the pile installation – mLogbook - as well as about the MOVAX piling equipment itself – mFleet Management.



PRODUCTS & SERVICES

VIBRATORY PILE DRIVERS

MOVAX Side grip pile drivers are excavator-mounted, high-frequency, vibratory-type pile drivers providing the optimum solution for a wide range of piling requirements – especially when a high degree of precision is required; and for piling in sensitive environments and when limited space, head room or access is available.

The same unit can handle, pitch and drive – and extract – different type of piles and is capable of accomplishing the entire piling process without the need of manual handling or assisting machinery.



FEATURES

- **Excavator-mounted**
Utilizing the hydraulic power and lifting capacity of the excavator or rail roader (carrier). Designed to work on any and all wheeled and crawler-type excavators and rail roaders by utilising and commanding the standard auxiliary hydraulics and/or by connecting to the electronic control of the excavator.
- **Comprehensive size range**
Available in different models, sizes and configurations for different piling requirements and different type of piles ranging sheet piles, trench sheets and, H-beams to tubular steel piles and timber piles; and for excavators ranging from 8 to 50 ton – thus always ensuring the optimum size and correct combination of vibratory pile driver and excavator.
- **Fixed or Variable**
Available with fixed eccentric moment (STD/LITE) or with resonance-free start/stop (V).
- **MOVAX Modular System**
Versatility based on the MOVAX Modular System™ which enables the use of the same unit for a wide range of different piling requirements, piling work and type of piles.
- **MOVAX Control System**
Controlled with the MOVAX Control System, mControl+ for productivity, precision and accuracy.
- **MOVAX Information Management System**
Available with the MOVAX MIMS Information Management System: mFleetManagement for monitoring MOVAX piling equipment operation, performance and condition; and mLogbook for monitoring and reporting the piling works.

Side grip vibratory pile drivers for
HANDLING, PITCHING, DRIVING AND EXTRACTING PILES



SIDE GRIP PILE DRIVERS

SELECTION

The suitable MOVAX side grip pile driver for a specific piling & foundation application is selected based on the soil & site conditions, the excavator and the main dimensions (weight & length) of the piles to be driven. The configuration i.e. the arms, clamps and/or pads of the MOVAX side grip pile driver is then defined by the type of piles to be driven.

Model (vibro technology)

MOVAX side grip vibratory pile driver-models are available based on two different (vibro)technologies: fixed eccentric moment (STD/LITE) and with resonance-free start/stop (V). Standard (STD) and Lite (N) models are selected for a wide range of piling jobs whereas Resonance-free (V) models are selected for sensitive areas where disturbances to the surroundings are to be minimized. All MOVAX side grip pile drivers are high frequency-type vibratory pile drivers.

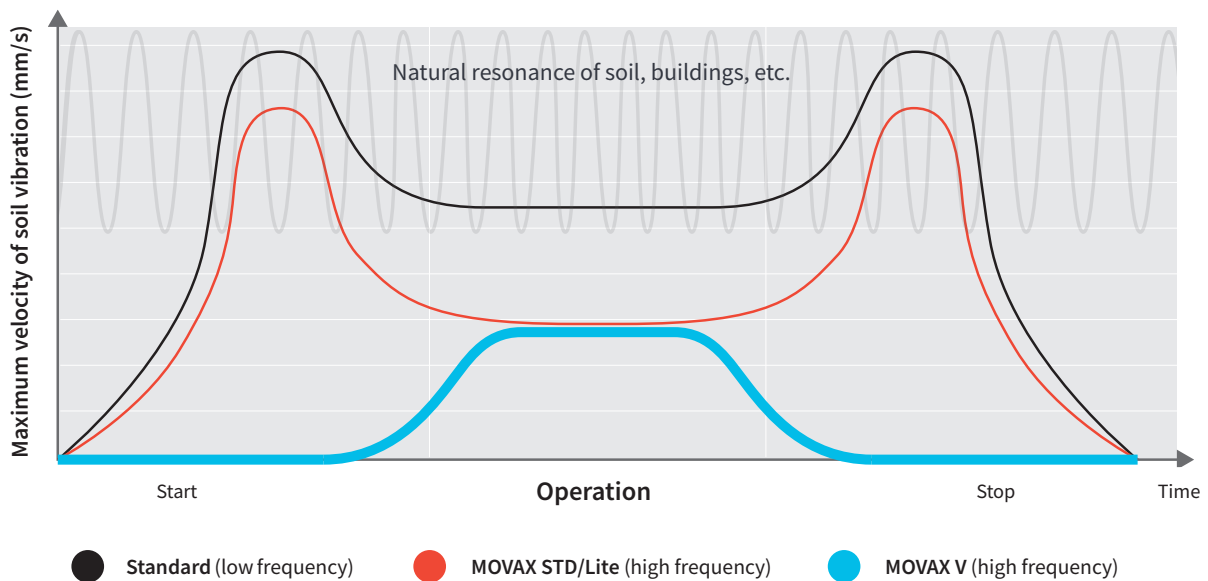

Excavator (carrier)

The excavator must be suitable – and match – the specific vibratory pile driver in question in regards to hydraulic power (oil flow @ pressure). Thus the excavator brand & model is needed for the correct selection of model.

Soil conditions

Vibratory pile drivers are suitable for a wide range of soil conditions & N-values (SPT). In order to make a detailed analysis of the suitability of a MOVAX model for a specific project a soil report is needed.

Type & dimension of piles

In order to select the correct MOVAX model, the type of piles (sheet pile, H-beam, tubular steel pile and/or timber pile) and their dimensions (length, width/depth, OD) are needed. Due to the modular design (*MOVAX Modular System*) the same MOVAX side grip pile driver can be used to drive different type of piles.

Site conditions

MOVAX side grip pile drivers are the optimum solution for sites with limited access, space or headroom. Standard (STD) and Lite models are selected for a wide range of piling jobs. Resonance-free (V) models are selected for sensitive areas where disturbances to the surroundings are to be minimized.

SELECTION CHART

EXCAVATOR CLASS/ PILE SIZE (length/weight)	33-50 t	28-32 t	23-28 t	20-24 t	17-21 t	13-16 t	7-11 t
6 m x 2800 kg 12 m x 1900 kg 16 m x 1300 kg	SG-75 SG-75V						
8 m x 2300 kg 12 m x 1800 kg 16 m x 1200 kg		SG-60 SG-60V	SG-50 SG-50V	SG-45 SG-45V			
6 m x 1200 kg 12 m x 1000 kg 16 m x 900 kg					SG-40N	SG-30N	
4 m x 400 kg 6 m x 200 kg							SG-15N
SUITABLE PILES							
Sheet piles / (trench sheets)		width 400-1200 mm			width 400-1200 mm (330-600 mm)		width 400-600 mm (330-600 mm)
H-beams		H100-H500			H100-H400		H100-H140
Timber piles		Ø160-600 mm			Ø120-325 mm		Ø100-200 mm
Tube piles		Ø88.9-1220 mm			Ø88.9-508 mm		Ø88.9- 323.9 mm

PRELIMINARY!

When making the final selection the excavator engine size and hydraulic system design (oil pump arrangement, oil flow rate/pressure etc.), excavator lifting capacity and stability and soil and site conditions shall be taken into account.

SIDE GRIP PILE DRIVERS

PILE HANDLING & DRIVING

MOVAX side grip pile drivers are capable of handling, pitching, driving and extracting a wide range of different piles including sheet piles, H-beams, tubular steel piles and timber piles without assisting machinery or manual handling and with the minimum number of assisting manpower. Furthermore there is no need for additional work, material and tools.



HANDLING

Suitable piles for
MOVAX WAY-OF-PILING

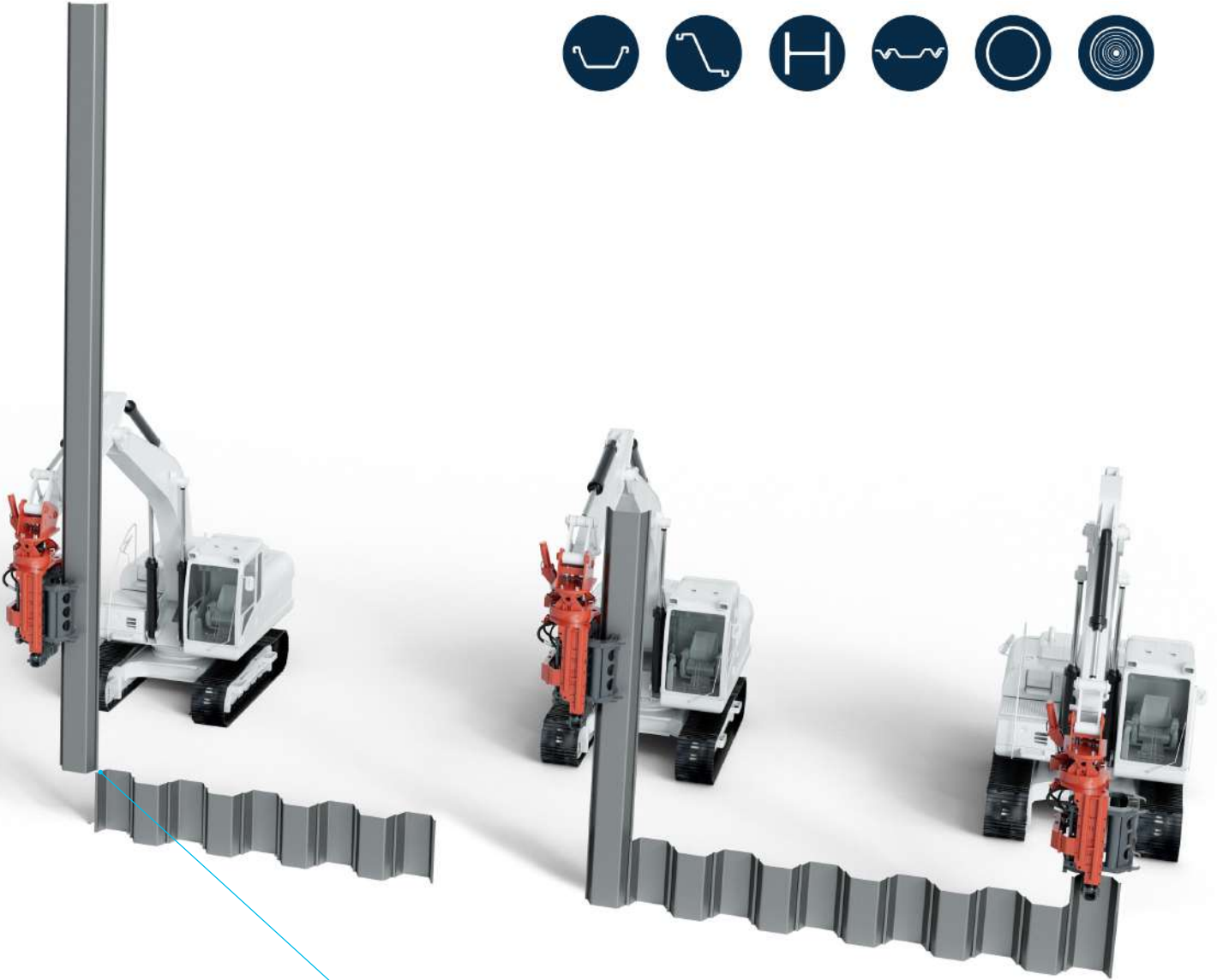

PITCHING

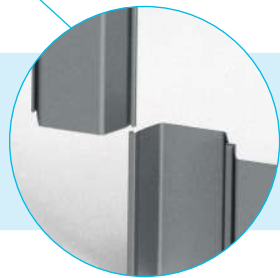

DRIVING/EXTRACTING

SIDE GRIP PILE DRIVERS, Standard TECHNOLOGY

STANDARD-MODELS

FIXED ECCENTRIC MOMENT

MOVAX STD- and LITE-models side grip vibratory pile drivers are high frequency (2300-300 rpm/38-50 Hz) vibratory pile drivers with fixed eccentric moment.

The STD- and LITE-models are suitable for a wide range of piling works in different soil and site conditions.

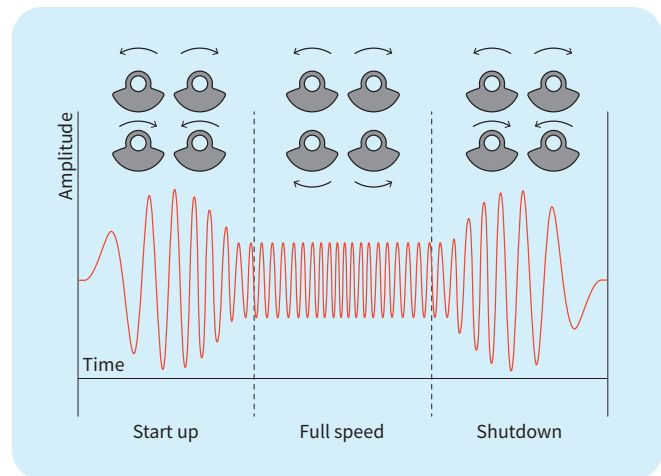

SIDE GRIP PILE DRIVERS, Standard

MOVAX MODULAR SYSTEM

The MOVAX Modular System (MMS™) enables the use of the same MOVAX side grip pile driver for a wide range of different type of piles ranging from sheet piles, H-beams and tubular steel piles to timber piles. The MOVAX Modular System includes interchangeable arms, clamps and pads that can easily and efficiently be changed for the different pile types in question.

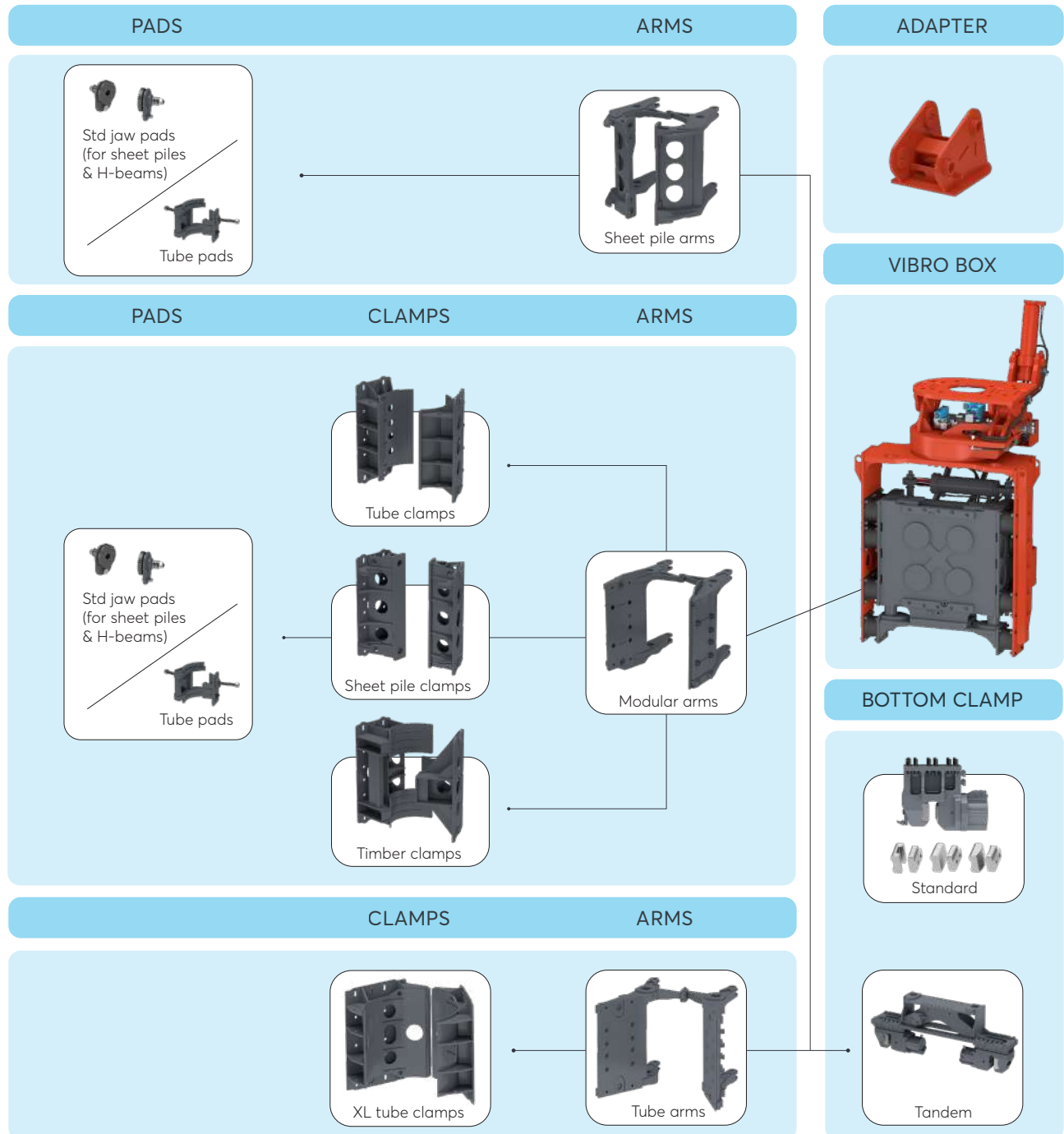

SIDE GRIP PILE DRIVERS, Standard

MOVAX MODULAR SYSTEM

The MOVAX Modular System (MMS™) enables the use of the same MOVAX side grip pile driver for different type of piles.

SHEET PILE ARMS



MODULAR ARMS



SHEET PILE CLAMPS



TUBE CLAMPS

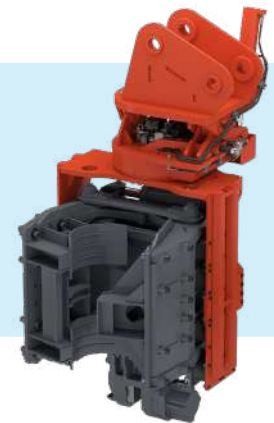

TIMBER CLAMPS

TUBE ARMS





SIDE GRIP PILE DRIVERS, Standard CONFIGURATIONS

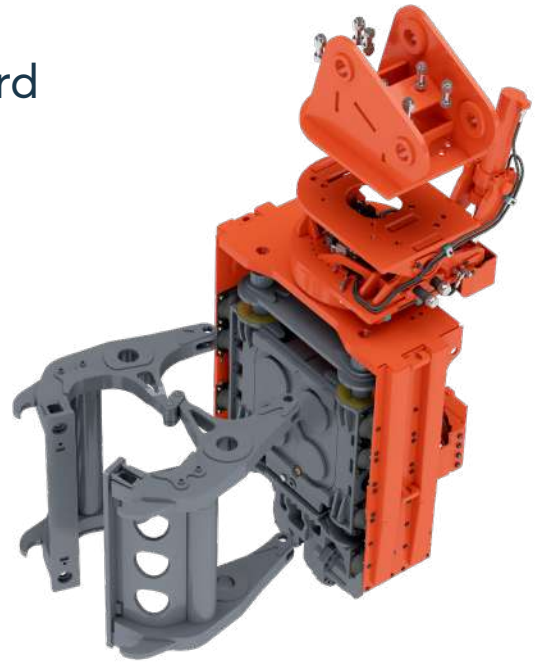

SHEET PILE ARMS

Special sheet pile arms are the optimum solution when handling, pitching, driving and extracting only – or mainly – sheet piles and/or H-beams.

The special sheet pile arms can also be utilised to drive smaller diameter tubular steel piles or micropiles up to OD 273 mm. Each tubular steel pile size requires its own, individual tube pads.



SHEET PILE PADS
for sheet piles and H-beams

Standard sizes
w 400–1200 mm
/ H180–H500



TUBE PADS
for tubular steel piles
from OD 88.9 mm to OD 273 mm

Standard sizes

Ø 88.9	Ø 127	Ø 219.1
Ø 101.6	Ø 139.7	Ø 273
Ø 114.3	Ø 168.3	

Customised sizes and special types, for instance for rail tracks, are available by request.

SHEET PILE ARMS are designed for the optimum handling, pitching and driving/extraction of sheet piles, H-beams and tube piles.



Clamp hooks



Clamping the web



Handling, pitching,
driving & extracting
H-beams

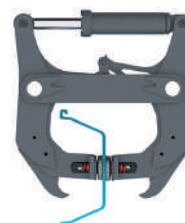

Handling, pitching,
driving & extracting
sheet piles



Handling, pitching,
driving & extracting
small OD tube piles



SIDE GRIP PILE DRIVERS, Standard CONFIGURATIONS

TUBE ARMS

Special modular tube arms are utilised to handle and drive large diameter tubes from 508 mm up to OD 1220 mm. Each tube size requires its own tube clamp in order to ensure proper operation.

A tandem bottom clamp is available for the same tube sizes as the tube arms for optimised pile driving of large tubes.

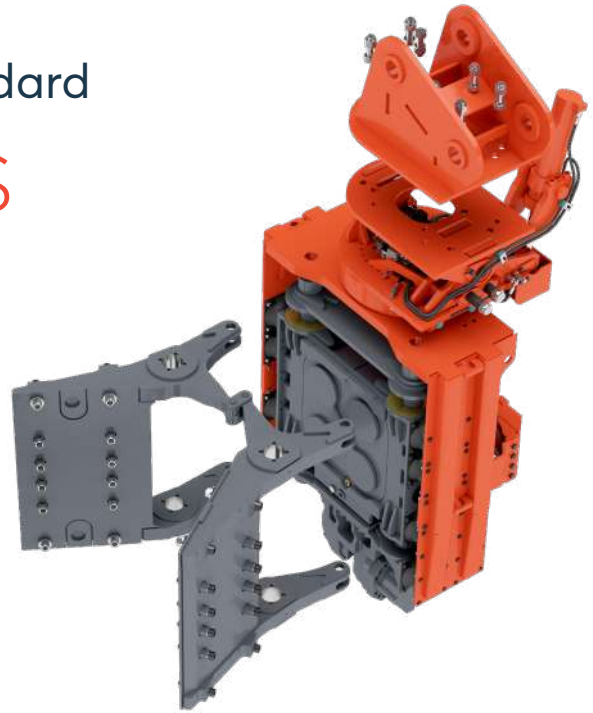

TUBE CLAMPS

for tubular steel piles from
OD 508 mm to OD 1220 mm

Standard sizes

Ø 508	Ø 762	Ø 1016
Ø 610	Ø 813	Ø 1220
Ø 711	Ø 914	

Customised sizes are available by request.

TANDEM BOTTOM CLAMP



TUBE PADS

Standard sizes

Tube pads for tandem bottom clamp from OD 508 mm up to OD 1220 mm



TUBE ARMS are designed for the optimum handling, pitching and driving/extraction of large OD tubes.



Handling, pitching, driving & extracting large OD tube piles

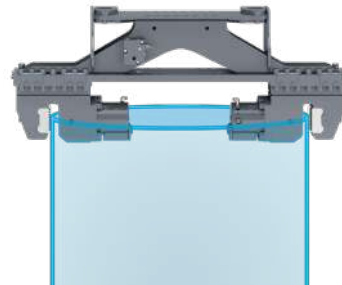

Tandem bottom clamp driving/extracting large OD tube piles



SIDE GRIP PILE DRIVERS, Standard CONFIGURATIONS

MODULAR ARMS

Modular arms are suitable for driving sheet piles, H-beams, tubular steel piles and timber piles.

Sheet pile clamps are utilised to drive sheet piles and H-beams. The sheet pile clamps can be equipped with tube pads for tubular steel piles up to OD 273 mm. Each tube size requires its own tube pads in order to ensure proper operation.

Tube clamps are utilised for tubular steel piles up to OD 762 mm. Each tube size requires also its own tube clamps.

Timber clamps are utilised to drive timber or wooden piles. A range of round timber piles can be driven with the same timber clamps whereas square timber piles requires clamps of the same size.

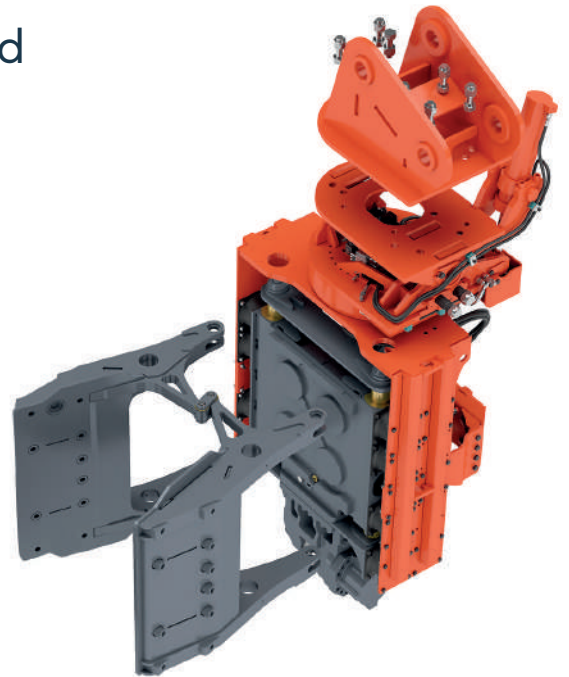



TUBE CLAMPS

for tubular steel piles from
OD 88.9 mm up to OD 762 mm:

Standard sizes

Ø 88.9	Ø 168.3	Ø 457
Ø 101.6	Ø 219.1	Ø 508
Ø 114.3	Ø 273	Ø 610
Ø 127	Ø 323.9	Ø 711
Ø 139.7	Ø 406.4	Ø 762



SHEET PILE CLAMPS

for sheet piles and H-beams/
tubular steel piles from OD 88.9 mm
to OD 273 mm:

SHEET PILE PADS

w 400–1200 mm/H180–H500



TUBE PADS

Standard sizes

Ø 88.9	Ø 139.7
Ø 101.6	Ø 168.3
Ø 114.3	Ø 219.1
Ø 127	Ø 273



TIMBER CLAMPS

for timber piles from
OD 160 mm up to 600 mm:

A range of round timber pile sizes
can be driven with the same
timber clamps.

Standard sizes

M Ø 160–420 mm
L Ø 430–600 mm

In addition clamps for square
timber piles are also available.
Each square timber pile size
requires clamps of matching size.

Customised sizes are available by request. (e.g. clamps for square timber piles or other special profiles).

MODULAR ARMS are designed for versatility and to handle, pitch, drive and extract sheet piles, tube piles or timber piles.



Handling, pitching,
driving & extracting
tube piles

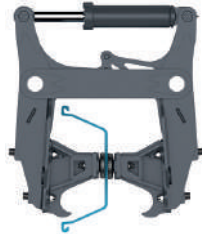

Handling, pitching,
driving & extracting
sheet piles



Handling, pitching,
driving & extracting
small OD tube piles



Handling, pitching,
driving & extracting
timber piles

SIDE GRIP PILE DRIVERS, Standard CONFIGURATIONS

BOTTOM CLAMP incl. OPTIONS

The (standard) bottom clamp is utilised for the completion of the pile driving and is suitable for all kinds of piles including sheet piles, H-beams and tubular steel piles.

The bottom clamp is equipped with pads for the specific pile type in question, Sheet pile pads are utilised for sheet piles and H-beams, Double (sheet) pile pads are recommended when driving double sheet piles (both U and Z). Tube pads are available in two sizes, from OD 323,9 mm to 508 mm and OD 508 mm to OD 762 mm; both covering the entire range as specified.

Smaller OD tube piles (from 88,9 mm to 323,9 mm and timber piles require a top hitter. The same top hitter is suitable for the entire range.

An optional 4th jaw can be provided for added pile handling capabilities.

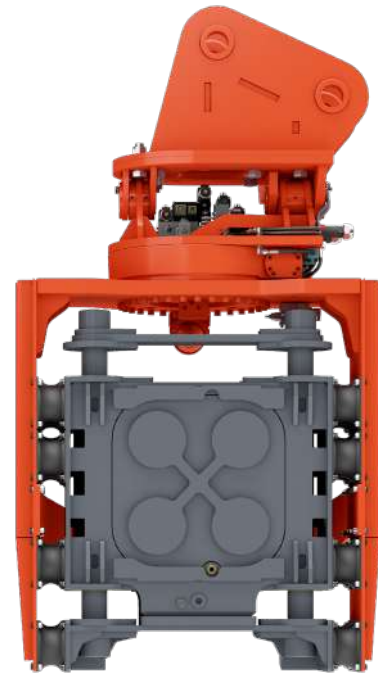

Top hitter (optional)

Smaller OD tube piles (from 88,9 mm to 323,9 mm and timber piles require a top hitter. The same top hitter is suitable for the entire range.



Top hitters for larger OD piles and f. ex. square timber piles are available by request.

Lifting lever

The bottom clamp is equipped with a lifting lever for handling of sheet piles.

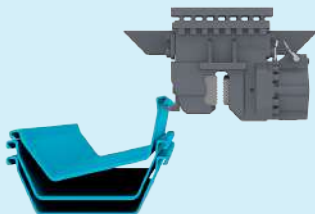

4th jaw (optional)

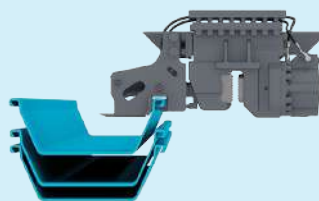

Sheet pile pads



Tube pads
OD 323,9...508 mm
OD 508...762 mm



Double (sheet) pile pads
Available for double-Z type sheet piles





SIDE GRIP PILE DRIVERS, Standard

TECHNICAL DATA

Model		SG-75	SG-60	SG-50	SG-45
Weight	kg	3330 - 3620	2550 - 2850	2400 - 2700	2390 - 2690
Height	mm	2615	2550	2530	2530
Depth	mm	1115	1180 - 1436	1180 - 1436	1180 - 1436
Width	mm	1270	1193	1193	1193
Frequency	1/min	2300 - 3000	2300 - 3000	2300 - 3000	2300 - 3000
Eccentric moment	kgm	7,6	6,1	5,1	4,6
Centrifugal force, max	kN	750	600	500	450
Ground vibration		normal	normal	normal	normal
Resonance-free start/stop		no	no	no	no
Driving method		vibration	vibration	vibration	vibration
Swing/tilt angle	°	360/30	360/30	360/30	360/30
Return pressure, max	bar	5	5	5	5
Pressure setting	bar	350	350	350	350
Excavator class	t	33-40	28-32	23-28	20-24
Engine power, min., TIER III	kW	180	135	125	100
Engine power, min., TIER IV	kW	200	160	135	120

Suitable piles					
Length & weight		6 m x 2800 kg	8 m x 2300 kg	8 m x 2300 kg	8 m x 2300 kg
		12 m x 1900 kg	12 m x 1800 kg	12 m x 1800 kg	12 m x 1800 kg
		16 m x 1300 kg	16 m x 1200 kg	16 m x 1200 kg	16 m x 1200 kg
Length & weight					
Sheet piles	width	400-1200 mm			
	depth	265 mm			
H-beams	size	H100-H500			
Timber piles	size	Ø 160 - 420 mm			
Timber piles	size	Ø 430 - 600 mm			
Tubular steel piles, tubes	size	Ø 88,9 - 762 mm (1220 mm)			





V
SERIES

STD
SERIES

LITE
SERIES



HIGHER PRODUCTIVITY - SIGNIFICANT SAVINGS
fast. efficient. versatile. accurate. safe. reliable.

Movax Oy

Tölkkimäentie 10
FI-13130 Hämeenlinna, Finland

Tel. +358 3 628 070
Fax +358 3 616 1641

marketing@movax.fi | movax.com

*Please refer to www.movax.com
for worldwide, certified partners.*

